

EN

KINGGates
idomus



minimodus

AUTOMATION FOR SWING GATES
WITH LEAVES UP TO 2 M - 250 KG



MiniModus

Automation for swing gates with leaves up to 2 m - 250 kg

EASY TO INSTALL

MiniModus is the gear motor with articulated arm for swing gates with leaves up to 2 m - 250 kg. **With just 155 mm in width, this gear motor allows its fixing also on small spaces while the geometry of the articulated arm guarantees its installation also on wide posts with distance between the axle of the leave and the fixing surface of the gear motor up to 240 mm.**

COMPACT AND SAFE

MiniModus holds inside a control unit and the housing for batteries which guarantee operations also after several hours after a black-out.

The release operation, as for all KINGgates products, is simple and fast while the fixing of the gear motor to a post and on the gate is fast and comfortable to the fitter. In fact, thanks to screw-adjustable brackets, it is not necessary any operation of welding.

SMART TRADITIONAL ELECTRONICS

STARG8 control units radically simplify the installer's job, guaranteeing high levels of performance in terms of safety, time and speed of installation.

A single programming method speeds up the activation of the automatic devices and managing maintenance operations becomes simple and practical.

STARG8

1 control unit 24 Vdc and 1 control unit 230 Vac, for all gate motors.

Practical regulation using trimmers, self-learning gate travel programming using a single key, diagnostic LEDs and dip-switches for setting operating modes. Management of slow-down options, speed regulation and obstacle control in all versions. Plastic cover with explanatory labels and spare fuses.

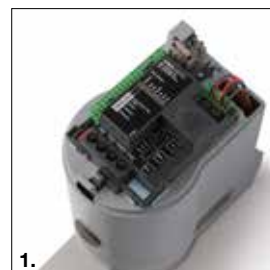

1.

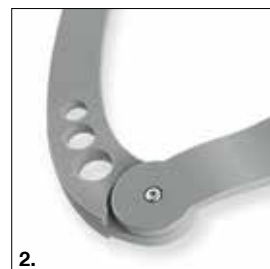

2.



3.

1. CONTROL UNIT

Fast regulation by trimmers and dip-switches, programming with self-learning function

2. ARTICULATED ARM

Strong die-cast aluminium arm with anti-shearing device

3. MECHANICAL LIMIT SWITCH

Strong adjustable steel limit switch

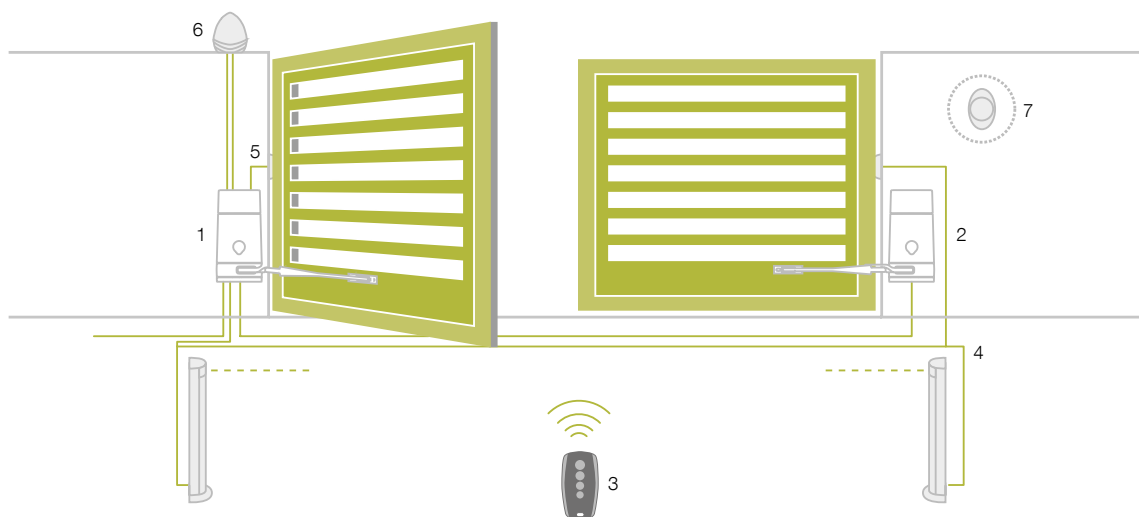

BASIC INSTALLATION

1. Operator MiniModus MA
2. Operator MiniModus SL
3. Transmitter
4. Photocells mounted on posts
5. Photocells
6. Flashing light
7. Key or digital switch

READY FOR





TECHNICAL DATA

Code		MINIMODUS
Mains power supply	(Vac 50 Hz)	230
Motor supply	(Vdc)	24
Maximum power draw	(W)	250 (100 slave)
Speed	(rpm)	1
Torque max	(Nm)	150
Working cycle	(%)	50
Protection level	(IP)	44
Operating temperature	(°C)	-20 ÷ +55
Automation weight	(kg)	6.2
Operator dimensions	(mm)	155x253x314 h

Also available in 110 V / 60 Hz version

MINIMODUS

Code	Motor	Control unit	Radio receiver	Mechanical stop	Fixing kit	Articulated arm	Wing max dimensions
MiniModus SL	24 Vdc	-	-	• (1)	•	•	2 m - 250 kg
MiniModus MA	24 Vdc	STARG8 24	•	• (1)	•	•	2 m - 250 kg

MINIMODUS KIT

Code	MINIMODUS MA	MINIMODUS SL	STYLO 4K	IDEA 24 PLUS	VIKY 30	NOVO LT 24 PLUS	NOVO PH 180	TAB	Wing max dimensions
MiniModus Kit 24	•	•	• (2)	•	•			•	2 m - 250 kg
MiniModus Kit 24 LT	•	•	• (1)		•				2 m - 250 kg
MiniModus Kit 24 NV	•	•	• (2)			•	•	•	2 m - 250 kg

24 V version also available for markets with 110 V / 60 Hz mains power supply



MINIMODUS MA



MINIMODUS SL



STYLO 4K



IDEA 24 PLUS



VIKY 30



TAB



NOVO LT 24 PLUS



NOVO PH 180





LOCK H0
Horizontal
electro lock 12 V



LOCK VE
Vertical
electro lock 12 V



BAT M 016
24 V 1.6 Ah battery



BAT K3
Battery charge card
for BAT M 016



STARG8 24
24 Vdc spare control unit

LIMITS OF USE FOR THE PRODUCT

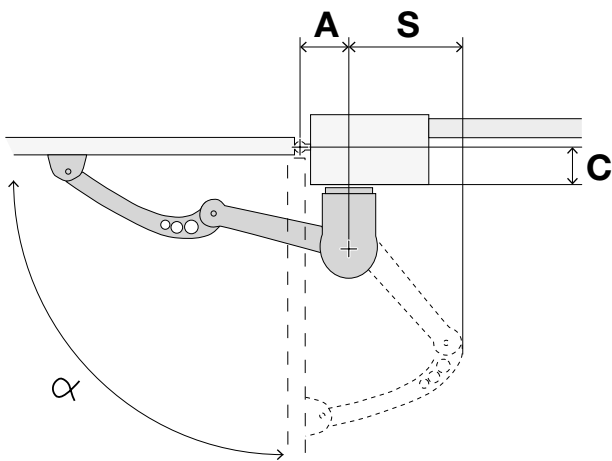

A	C	S	α
130	30	60	95
180	30	110	105
135	60	65	95
195	60	125	105
140	90	70	95
205	90	135	105
140	120	75	95
220	120	155	105
145	150	80	95
230	150	170	105
150	180	85	95
250	180	185	105
165	210	100	95
205	240	170	95

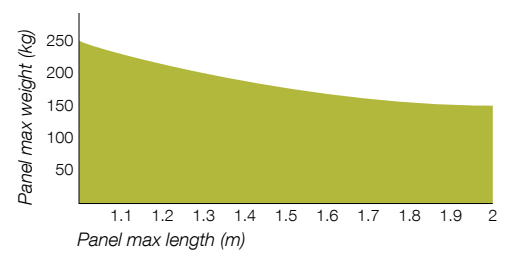
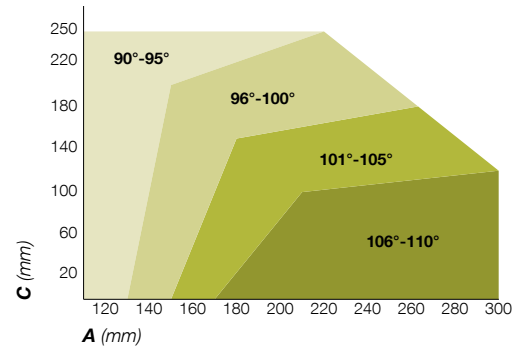

THE KING SPECIALIST



KINGspecialist app for installers

The KINGspecialist app allows you to complete all installation setup phases directly from your smart phone or tablet.

Thanks to the wifi module,

which can be coupled to STARG8 central units, every professional can now manage all the functions offered by the KING Smart Traditional electronic device simply and intuitively.

The App also introduces new functions, such as scheduling of periodical system maintenance, central unit check-ups and remote control management.

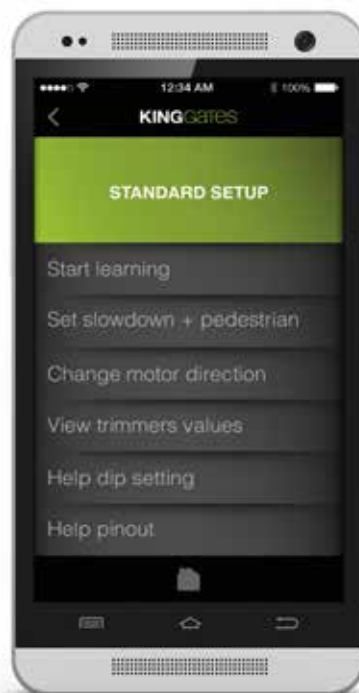

KINGgates relies on a network of expert professional installers.

KINGspecialist is a programme available only to installers: KINGgates quality in the form of a service. Installer-friendly innovations and continuous updates to keep growing together.



IDOMUS UAB
V.Krėvės av. 129, LT-50312,
Kaunas Tel.: +370 37 308 900
Faks.: +370 37 308 907
info@idomus.lt
www.idomus.lt